

URBAN GARDEN

Pflanzenanleitung/ Planting manual

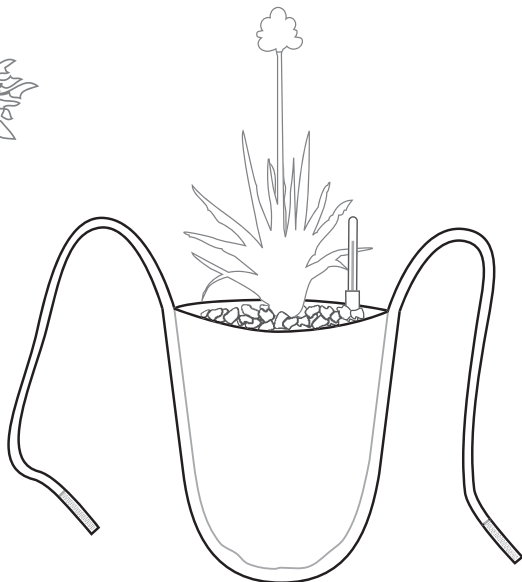
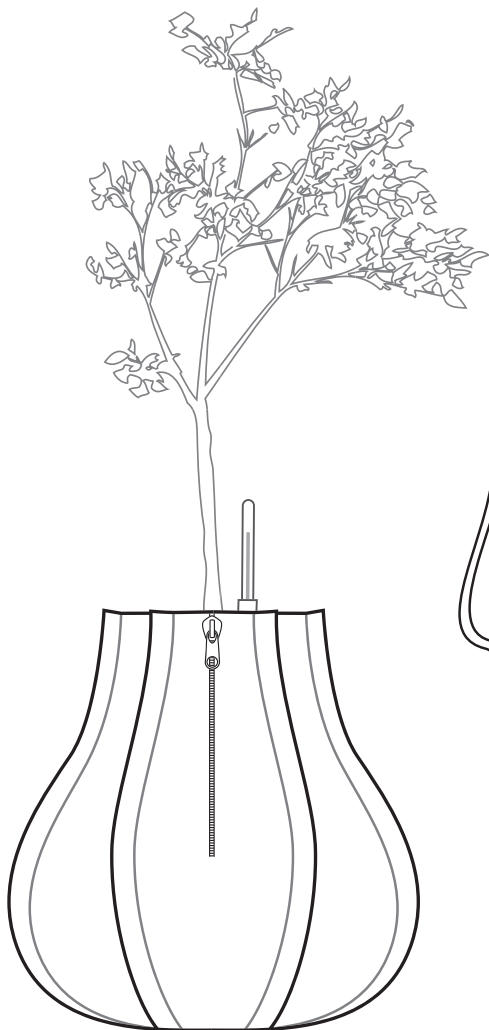

Inhaltsverzeichnis/ Content

- 1 Pflanzsack / Plant Sack
- 5 Pflanztasche / Plant Bag
- 9 Deckenabhängung / Ceiling Hooks
- 10 Wandbefestigung / Wall Fitting
- 11 Pflanztasche Sx3 / Plant Bag Sx3

PFLANZSACK / PLANT SACK

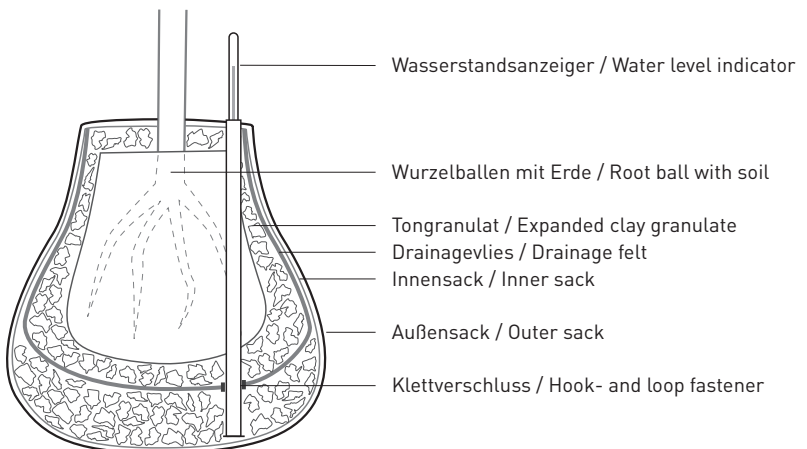
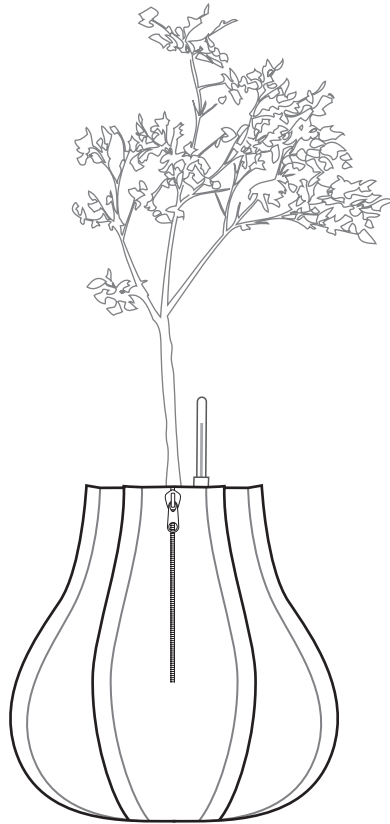

Lieferumfang / Included parts



1x



1x



2x



1x

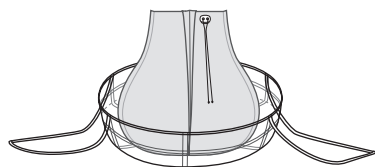
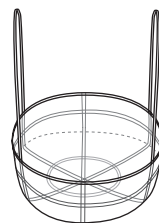

1. Innensack in Tragehilfe stellen /
Place inner sack into carrying aid

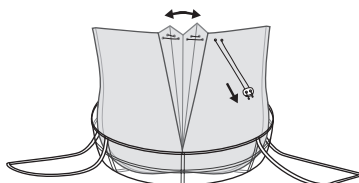

2. Band lockern / Unfasten the belt

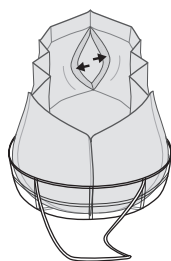

3. Klettverschluss im Drainagevlies
öffnen / Open the hook- and loop
fastener in the drainage felt

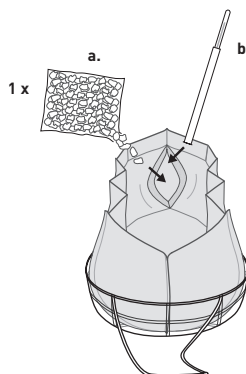

4. Tongranulat (a.) durch Öffnung einfüllen
und Wasserstandsanzeiger (b.) einführen /
Fill with expanded clay granulate (a.)
through the opening and insert the water
level indicator (b.)

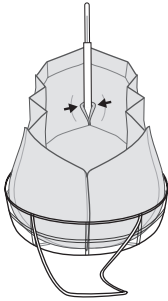

5. Klettverschluss schließen und Wasserstandsanzeiger fixieren / Close the hook- and loop fastener and fix the water level indicator in place

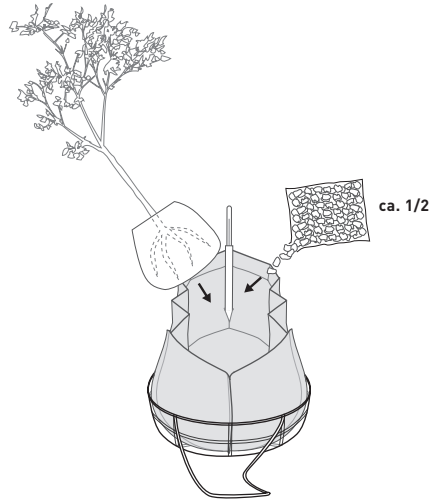

6. Pflanze mit Wurzelballen in die Vlieskammer setzen und rundum mit Tongranulat auffüllen und andrücken / Place the plant including its root ball into the felt chamber, fill with and slightly compress the clay granulate all round

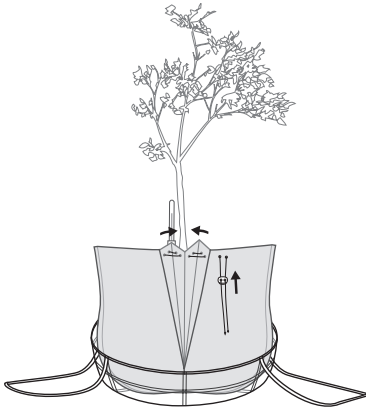

7. Band festziehen / Pull the belt tight

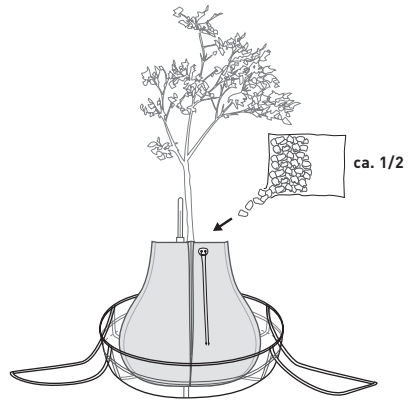

8. Weiteres Tongranulat auf den Wurzelballen auffüllen und leicht andrücken / Add more clay granulate on top of the root ball and slightly compress

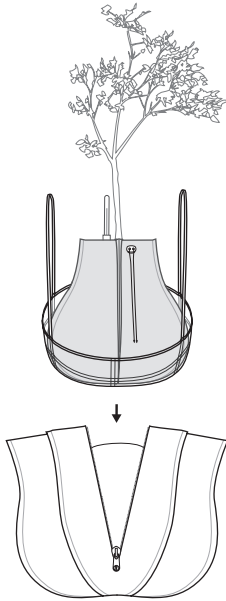

9. Innensack mit Pflanze in den Außensack stellen / Place the inner sack with the plant into the outer sack

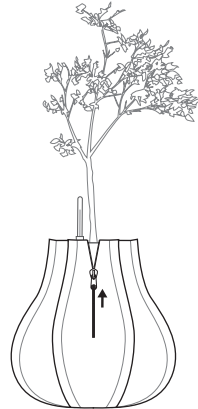

10. Reißverschluss schließen / Close zipper

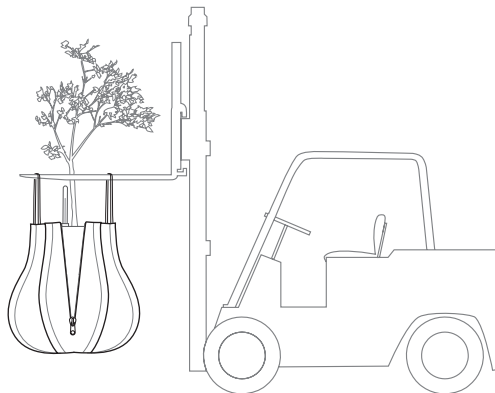

Achtung:

Pflanzsack nur mit geöffnetem Reißverschluss des Außensackes transportieren

Note:

Only transport the plant sack with the zipper of the outer sack opened

PFLANZTASCHE / PLANT BAG

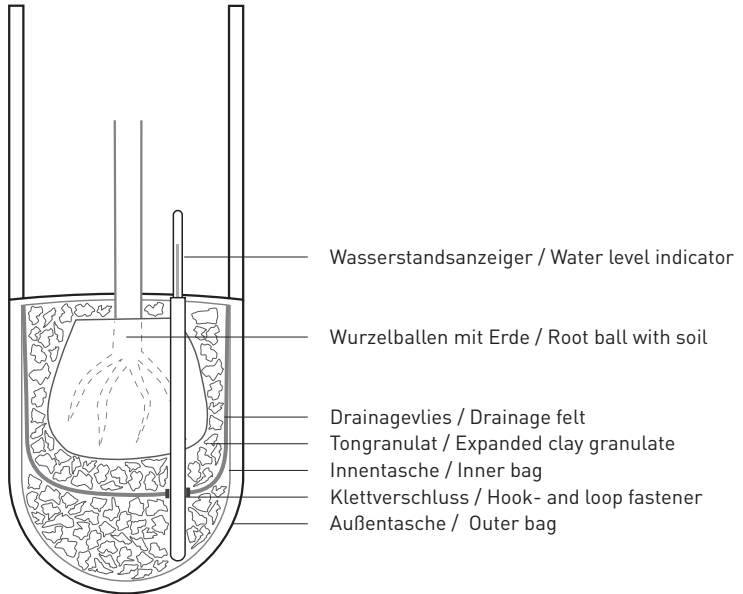
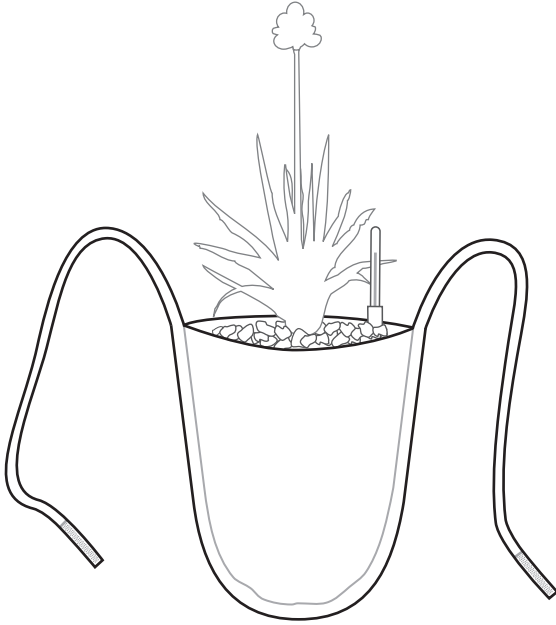

Lieferumfang / Included parts

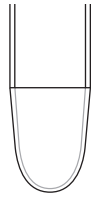

1 x



1 x



2 x



2 x

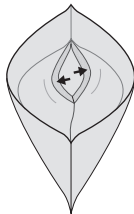

1. Klettverschluss im Drainagevlies öffnen / Open the hook- and loop fastener in the drainage felt

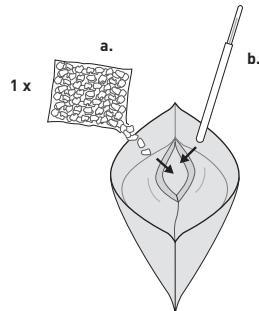

2. Tonggranulat (a.) durch Öffnung einfüllen und Wasserstandsanzeiger (b.) einführen / Fill with expanded clay granulate (a.) through the opening and insert the water level indicator (b.)

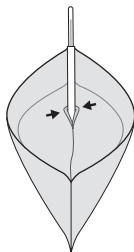

3. Klettverschluss schließen und Wasserstandsanzeiger fixieren / Close the hook- and loop fastener and fix the water level indicator in place

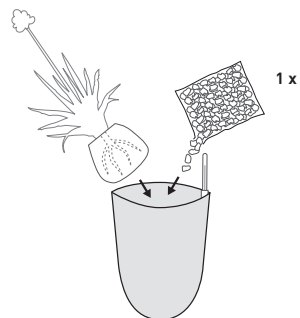

4. Pflanze mit Wurzelballen in die Vlieskammer setzen und mit Tonggranulat auffüllen / Place the plant including its root ball into the felt chamber and fill with clay granulate

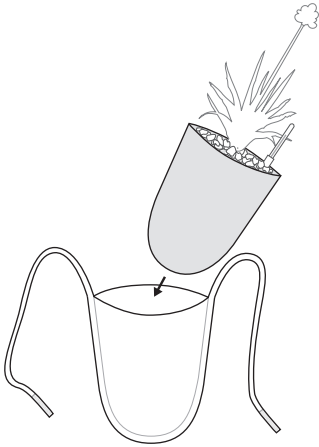

5. Innensack mit Pflanze in die Außentasche stellen / Place the inner sack with the plant into the outer bag

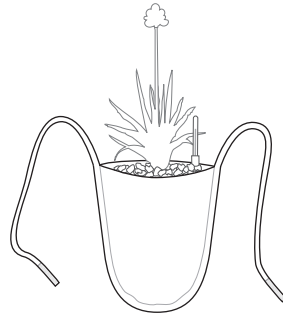

6. Tasche aufhängen / Suspend the bag

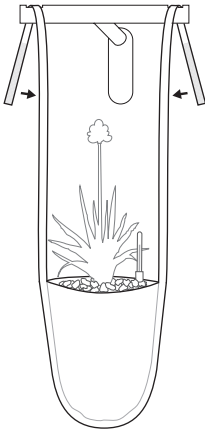

- Hängung**
1. Tragriemen über Wandhalterung ziehen (Wandhalterung nicht im Lieferumfang enthalten)

How to suspend

Pull the belts over the wall fitting (wall fitting not included)

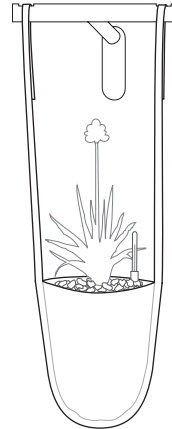

2. Tragriemen mit Klettverschlüssen fixieren / Fix the belts with hook-and loop fasteners

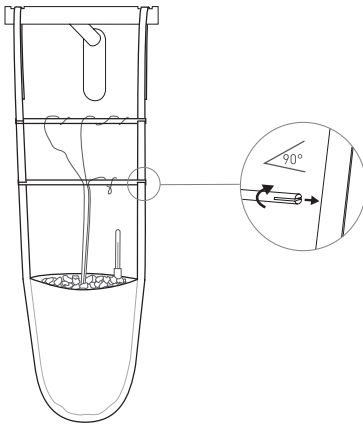

Rankstangen

Rankstangen 90° versetzt in die Tragriemen einfädeln

Climber rods

Attach the climber rods to the belts in a 90° offset pattern

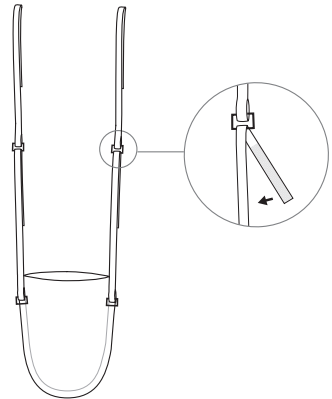

Gurtverlängerungen (Zubehör)

Trageriemen der Pflanztaschen durch Metalllaschen der Gurtverlängerungen ziehen und fixieren

Belt extensions (accessory)

Pull the belts of the planting bags through the metal lugs of the belt extensions and fix

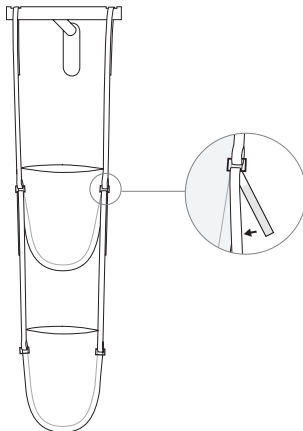

Taschenkette

Zur Befestigung weiterer Taschen Tragriemen durch Metalllasche ziehen

Bag chain

For fastening more bags, pull the belts through the metal lug



Achtung:

Maximal 5 Taschen aufhängen

Note:

Do not suspend more than 5 bags

DECKENHAKEN / CEILING HOOKS

Lieferumfang / Included parts



2 x



1 x

Dübel sind nicht im Lieferumfang enthalten! Bitte erkundigen Sie sich im Fachhandel nach dem geeigneten Befestigungsmittel für Ihre Decke. / Dowels are not included. The specialist trade provides suspension means suitable for your ceiling.

Abstand/distance: S = 14 cm
M = 18 cm
L = 23 cm

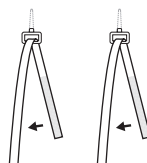
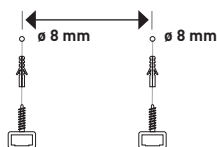

1. Deckenabhängung in Decke befestigen / Fasten hook in ceiling

2. Trageriemen durch Deckenhaken ziehen / Pull belt through the ceiling hook

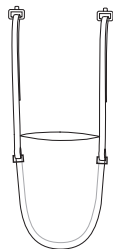

3. Mit Klettverschlüssen fixieren / Fix with hook- and loop fasteners



max. 5

Achtung:

Maximal 5 Taschen aufhängen

Note:

Do not suspend more than 5 bags

WANDBEFESTIGUNG / WALL FITTING

Lieferumfang / Included parts

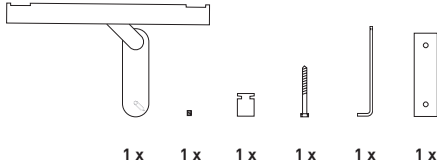

Dübel sind nicht im Lieferumfang enthalten! Bitte erkundigen Sie sich im Fachhandel nach dem geeigneten Befestigungsmittel für Ihre Decke. / Dowels are not included. The specialist trade provides suspension means suitable for your ceiling.

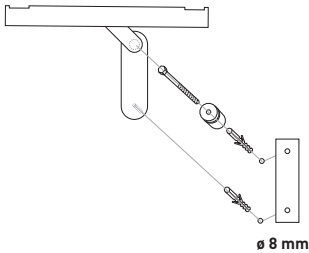

1. Wandbefestigung an der Wand anbringen / Fasten the wall fitting to the wall

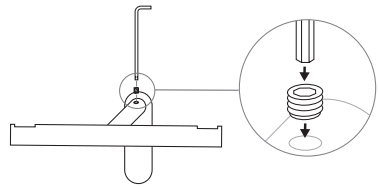

2. Mit Inbusschlüssel fixieren / Tighten with an Allen® key

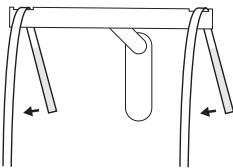

3. Riemen an die Wandbefestigung hängen / Suspend the belts from the wall fitting

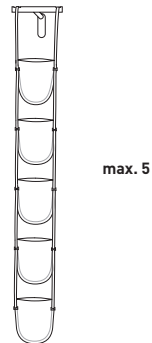

Achtung:
Maximal 5 Taschen aufhängen
Note:
Do not suspend more than 5 bags

PFLANZTASCHE Sx3 / PLANT BAG Sx3

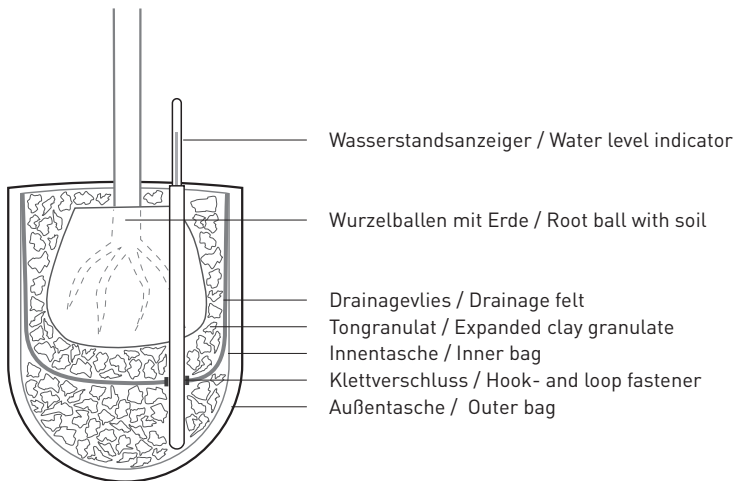
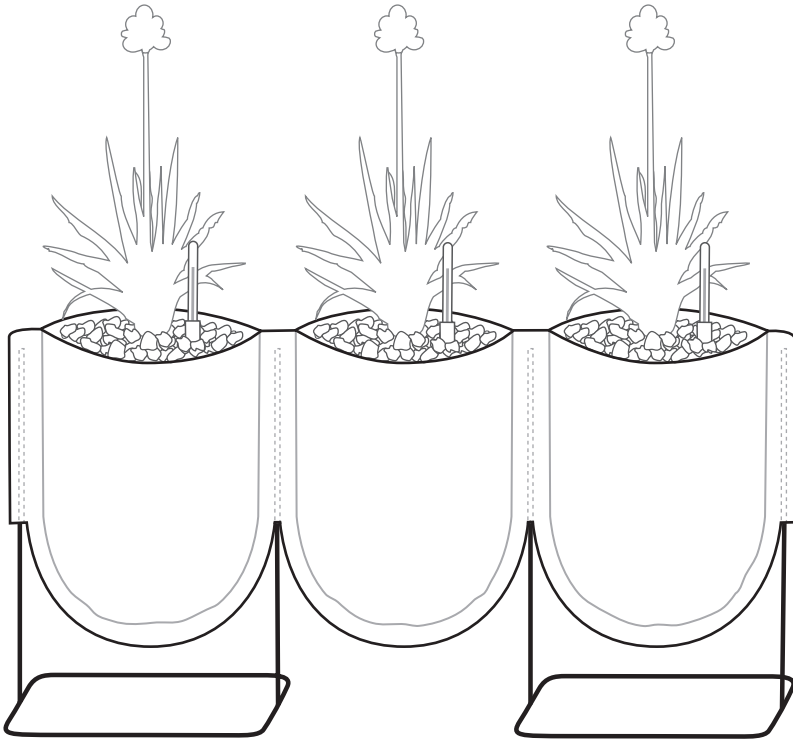

Lieferumfang / Included parts

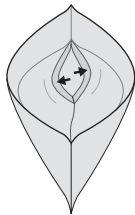
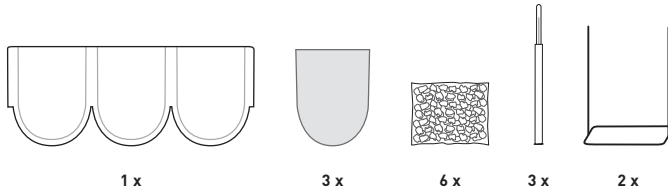

1. Klettverschluss im Drainagevlies öffnen / Open the hook- and loop fastener in the drainage felt

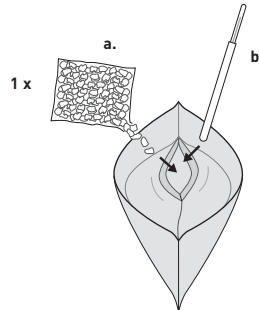

2. Tonggranulat (a.) durch Öffnung einfüllen und Wasserstandsanzeiger (b.) einführen / Fill with expanded clay granulate (a.) through the opening and insert the water level indicator (b.)

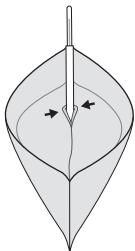

3. Klettverschluss schließen und Wasserstandsanzeiger fixieren / Close the hook- and loop fastener and fix the water level indicator in place

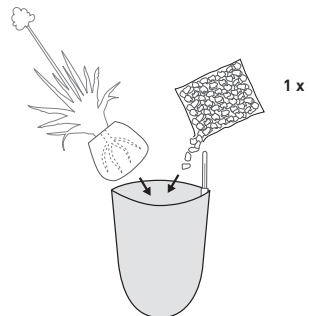

4. Pflanze mit Wurzelballen in die Vlieskammer setzen und mit Tonggranulat auffüllen / Place the plant including its root ball into the felt chamber and fill with clay granulate

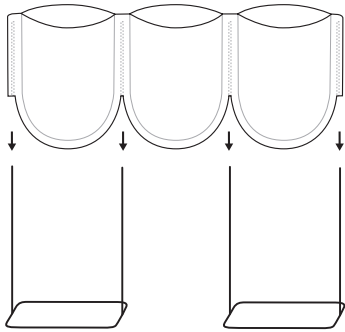

5. Außentaschen auf die Ständer stecken /
Slide the outer bags over the stand rods

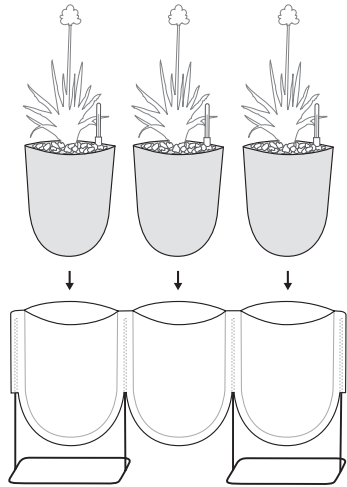

6. Innentaschen mit Pflanzen in die Außentaschen stellen / Place the inner bags with the plants into the outer bags

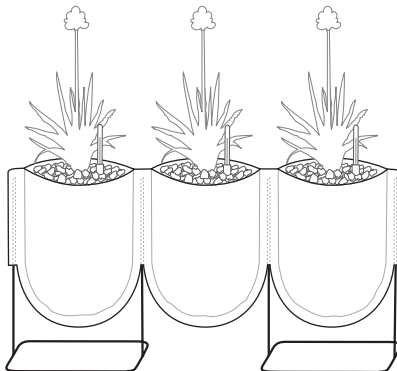

ALLGEMEINE HINWEISE

Die artgerechte Versorgung der eingesetzten Pflanze ist durch ausreichende Zugabe von Wasser, Dünger und Spurenelementen unter Berücksichtigung des erforderlichen PH-Wertes sicherzustellen.

Die Menge des einzufüllenden Tongranulates richtet sich nach der Größe des Wurzelballens und der einzusetzenden Pflanze.

 Für stark wurzelnde Pflanzen unbedingt ein Wurzel-Stop-Vlies verwenden!

Dübel sind nicht im Lieferumfang enthalten. Bitte erkundigen Sie sich im Fachhandel nach dem geeigneten Befestigungsmittel für Ihre Wand oder Decke.

 Nicht für den Außenbereich geeignet.
Nicht geeignet für Temperaturen unter 5°C (41°F) und über 40°C (104°F)!

GENERAL INFORMATION

Ensure the supply proper for the type of plant by sufficient water, fertiliser and trace elements while taking the required pH value into account.

The quantity of clay granulate to be filled in depends on the size of the root ball and the plant chosen.

 A special anti-root felt must be used for plants with strong roots!

Dowels are not included.
The specialist trade provides suspension means suitable for your ceiling.

 Not intended for outdoor use.
Not suitable for temperatures below 5° C (41° F) and above 40° C (104° F)!

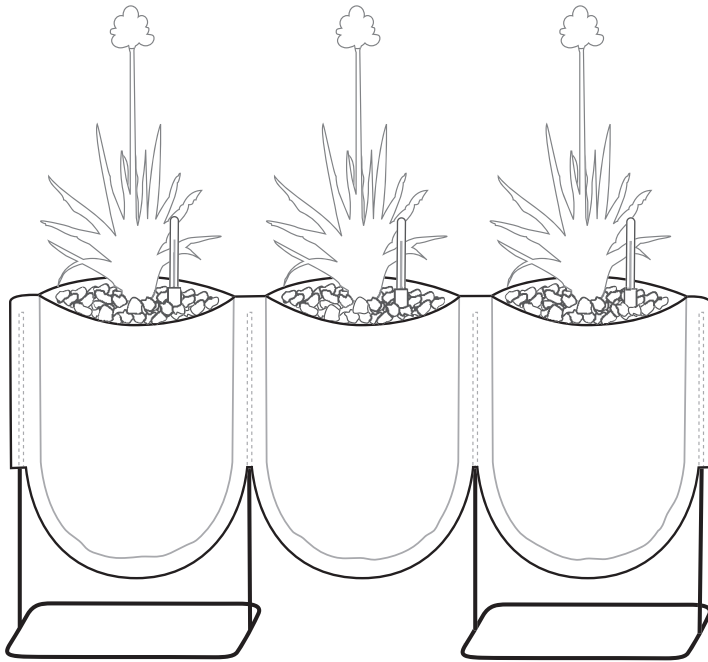

AUTHENTICS[®]

Authenticity GmbH
Am Ölbach 28
33334 Gütersloh
Deutschland
www.authenticity.de